

TOP VIEW

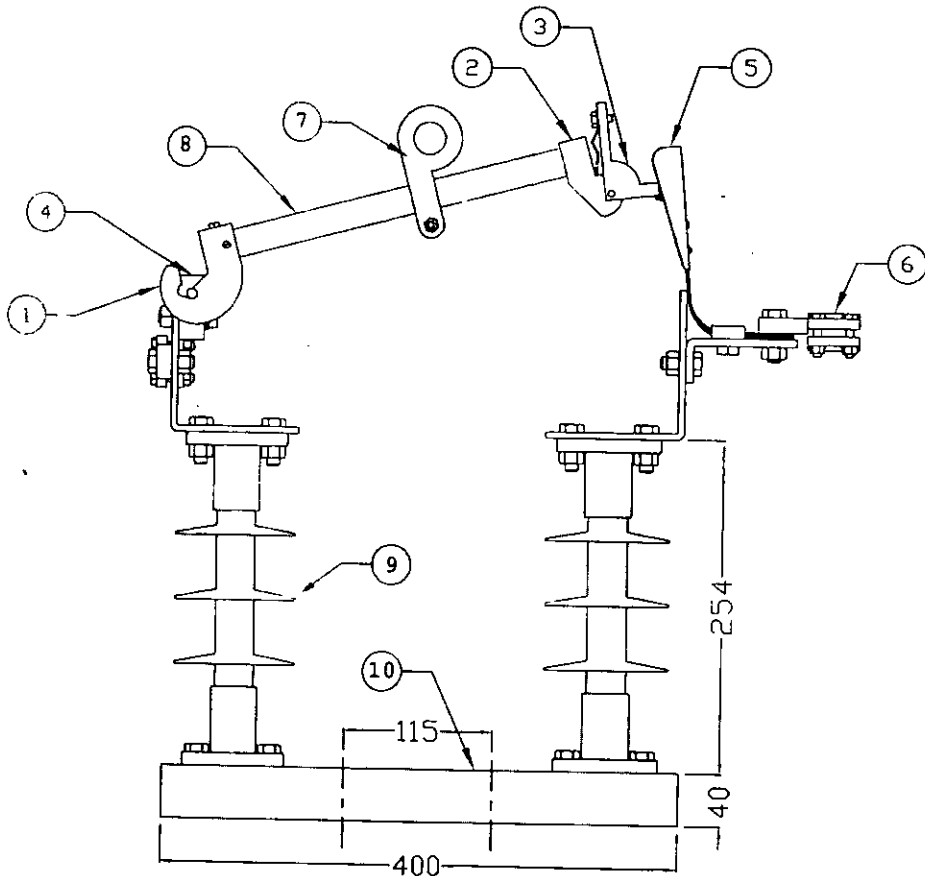

ELEVATION

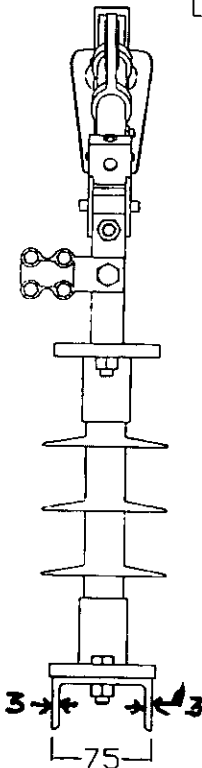

SIDE VIEW

No.	PART NAME	QTY.	MATERIAL	SURFACE TREATMENT
10	BASE CHANNEL C75X40X400	1	M.S.	HOTDIP GALV.
9	11KV POLY. INSULATOR 320MM C.D.	2	POLYMERIC	-
8	F.R.P. TUBE	1	-	-
7	AL. ALLOY HOOK	1	AL. ALLOY	-
6	TERMINAL CONNECTOR	2	AL. ALLOY	-
5	TOP CONTACT	1	COPPER ALLOY	SILVER PLATED
4	BOTTOM CONTACT	1	COPPER ALLOY	SILVER PLATED
3	TOP LEVER	1	COPPER ALLOY	SILVER PLATED
2	TOP ASSEMBLY	1	COPPER ALLOY	SILVER PLATED
1	BOTTOM ASSEMBLY	1	COPPER ALLOY	SILVER PLATED

[Signature]
Chief Engineer (Project)
PGVCL, Corporate Office,
RAJKOT.

NOTE

1. ALL DIMENSIONS ARE IN MM.
2. GENERAL TOLERANCE SHALL BE $\pm 5\%$, MIN. 1 MM.

PASCHIM GUJARAT VIJ COMPANY LTD.
 "PASCHIM GUJARAT VIJ SEVA SADAN"
 OFF NANA MAVA MAIN ROAD, RAJKOT

TITLE : GENERAL ARRANGEMENT DRAWING OF 11kv DO FUSE
 (100 AMPS) WITH POLYMERIC INSULATOR.

DRG. NO. : PGVCL/T-3/DO/10	SHEET : 1 OF 2	SCALE : 1 : 1
	DATE :	REVISION :

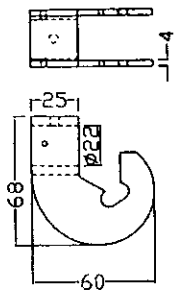

1. BOTTOM ASSEMBLY

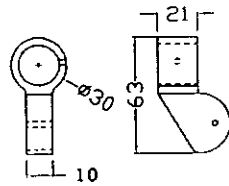

2. TOP ASSEMBLY

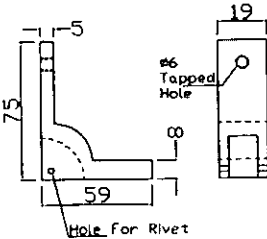

3. TOP LEVER

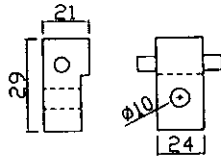

4. BOTTOM CONTACT

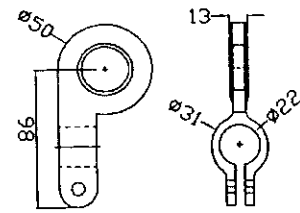

7. ALL ALLOY HOOK

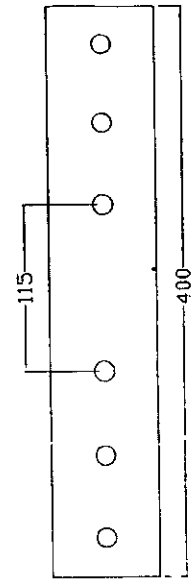

10. BASE CHANNEL

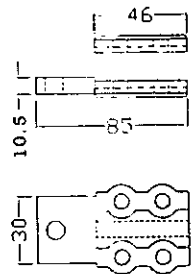

6. TERMINAL CONNECTOR

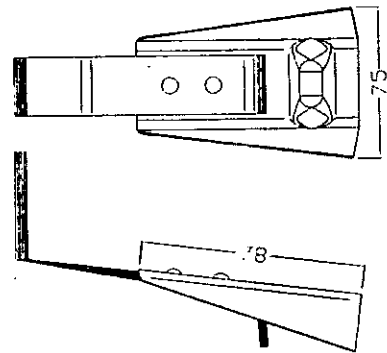

5. TOP CONTACT ASSEMBLY

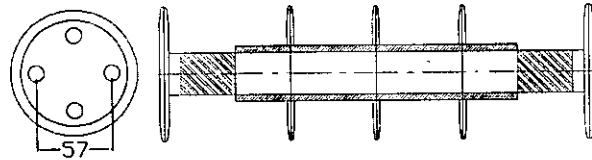

CREEPAGE DISTANCE: 320 MM

9. 11KV POLYMERIC INSULATOR

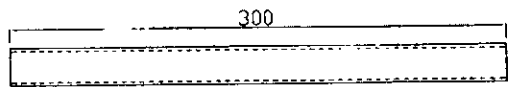

8. F.R.P. TUBE (Ø22 X Ø17 MM)

No.	PART NAME	QTY.	MATERIAL	SURFACE TREATMENT
10	BASE CHANNEL C75X10X300	1	M.S	HOT DIP GALV.
9	SOLID CORE INSULATOR	2	POLYMERIC	-
8	F.R.P. TUBE	1	-	-
7	AL. ALLOY HOOK	1	AL. ALLOY	-
6	TERMINAL CONNECTOR	2	AL. ALLOY	-
5	TOP CONTACT ASSEMBLY	1	COPPER ALLOY	SILVER PLATED
4	BOTTOM CONTACT	1	COPPER ALLOY	SILVER PLATED
3	TOP LEVER	1	COPPER ALLOY	SILVER PLATED
2	TOP ASSEMBLY	1	COPPER ALLOY	SILVER PLATED
1	BOTTOM ASSEMBLY	1	COPPER ALLOY	SILVER PLATED

Chief Engineer (Project)
PGVCL, Corporate Office,
RAJKOT.

NOTE:
 1. ALL DIMENSIONS ARE IN MM.
 2. IN DIMENSIONS TOLERANCE SHALL BE ±5% MIN. 1MM.

PASCHIM GUJARAT VIJ COMPANY LTD.
 "PASCHIM GUJARAT VIJ SEVA SADAN"
 OFF NANA MAVA MAIN ROAD, RAJKOT

TITLE : **DETAIL OF PARTS DRAWING FOR 11KV DO FUSE (100AMPS) WITH POLYMERIC INSULATOR**

DRG. NO. : PGVCL/1-3/DO/10	SHEET : 2 OF 2	SCALE : 1 : 1
DATE :	REVISION :	